

CELLTRON ADVANTAGE

Instruction Manual



Table of Contents

Safety	3-4
Specifications	5
Product Overview	6-9
Hot Keys	10
Main Menu Overview	11-13
Performing a Test	14-16
Reports	17
Add-Ons/Expansion Modules	18-20
Accessories	21
Troubleshooting	22-23

Safety Guidelines

General Safety Precautions

1. IMPORTANT SAFETY INSTRUCTIONS. **IT IS OF UTMOST IMPORTANCE THAT BEFORE USING YOUR TESTER, YOU READ THIS MANUAL AND FOLLOW THE SAFETY AND OPERATING INSTRUCTIONS EXACTLY. SAVE THESE INSTRUCTIONS.**

Risk of explosive gases

Batteries generate explosive gases during normal operation, and when discharged or charged.

- 1.1 To reduce risk of battery explosion, follow these safety instructions and those published by the battery manufacturer and the manufacturer of any equipment you intend to use in the vicinity of a battery. Review cautionary marking on these products and on the engine, and on the vehicle or equipment containing the battery.
If you are uncertain as to the type of battery you are trying to test, then contact the seller or battery manufacturer.
- 1.2 Do not operate the tester if it has received a sharp blow, been dropped or otherwise damaged in any way; take it to a qualified service center.
- 1.3 Do not disassemble tester; take it to a qualified service center when repair is required. Incorrect reassembly may result in a risk of electric shock or fire.
- 1.4 Test batteries in a dry, well-ventilated area.
- 1.5 Do not expose the tester to rain or snow.

Personal Precautions

- 2.1 Always have someone within range of your voice, or close enough to come to your aid, when working around lead acid batteries.
- 2.2 Have plenty of fresh water and baking soda nearby in case battery acid contacts skin, clothing or eyes.
- 2.3 Wear complete eye protection, clothing protection, and wear rubber soled shoes. Place damp cloth over battery to protect against acid spray. When ground is very wet or covered with snow, wear rubber boots. Avoid touching eyes while working near battery.
- 2.4 If battery acid contacts skin or clothing, wash immediately with baking soda and water. If acid enters the eye, immediately flush with cold running water for at least 10 minutes, and seek medical attention.
- 2.5 NEVER smoke or allow a spark or flame in vicinity of a battery or engine.
- 2.6 Be extra cautious to reduce risk of dropping a metal tool onto the battery. It might spark or short circuit the battery or other electrical part that may cause an explosion.
- 2.7 Before working with a lead-acid battery, remove personal metal items such as rings, bracelets, necklaces, watches, etc. A lead-acid battery can produce a short circuit current high enough to weld such items causing a severe burn.

Testing Precautions



IMPORTANT: Read this instruction manual before using the tester.

WARNING

To avoid electric shock when testing jars, follow your company's safety practices and these guidelines:

- Wear safety glasses or a face shield.
- Wear protective rubber gloves
- Wear a protective apron or shop coat.
- Perform service work only for which you have been trained
- Do not disconnect the battery cables from power systems during the test without authorization
- Do not place yourself in an electrical circuit
- Avoid simultaneous contact with the jar and with frame racks or hardware that may be grounded
- Battery posts, terminals, and related accessories contain lead and lead compounds, chemicals known to cause cancer and birth defects or other reproductive harm.
Wash hands after handling.

Model Numbers:

CAD-5000 (Bronze Kit)

CAD-5200 (Silver Kit)

CAD-5500 (Gold Kit)

Applications:

Tests individual Lead-Acid or Nickel-Cadmium cells or Monoblocs (up to 16Volts) in any common configuration, approximately 10-6000Ah.

Voltage Range:

0.8 - 16.0 Volts DC

Conductance Range:

100 - 19,990 Siemens

Test Data Storage:

50 string locations of 280 test results stored internally

Accuracy:

+/-2% across test range, Voltage and Conductance

Voltmeter Resolution:

5mV

User Programmable Functions:

- Preset values for over 250 battery types
- Low voltage alarm setting
- Low conductance warning
- Low conductance failure
- Test mode (pushbutton/auto start)

Calibration:

Auto-calibration prior to every test, no future calibration required Connectorized Test

Cable Options:

- Dual contact clamps
- Dual contact probes
- Custom cables by quotation

Power Requirements:

7.2V, 2500mAh, NiMH

Internal swappable battery & charger

Display:

LCD- FST 2.97 in x 2.81 in (75.4 mm x 71.3mm), 128 x 128 pixels, 40 degree viewing angle, contrast ratio 8, LED backlight

continued →

Keypad:

Alpha-numeric, Stainless-steel dome, polycarbonate overlay, 1,000,000 actuations

Data Transfer:

USB Flash Drive (Type A)
USB PC Interface (Type B)
Infra-red, half-duplex IRDA Protocol for printer

Environmental Operating Range:

0 to +40°C, 95% relative humidity, non-condensing

Storage Temperature:

-20 to 82°C

Over Voltage Protection:

- Auto-reset disconnect
- Reverse polarity protected

Housing Material:

Acid-resistant ABS plastic
Santoprene overmold

Analyzer Dimensions:

11inx4inx3in 2
80mmx105mmx80mm

Case Dimensions:

19inx15.5inx7in
485mmx395mmx180mm

Analyzer Weight:

1 Kg/2.6 lb
CAD-5500 Test Kit Shipping Weight:

Approximately 5 Kg/11 lb

CELLTRON ADVANTAGE

Product Overview

Product Map

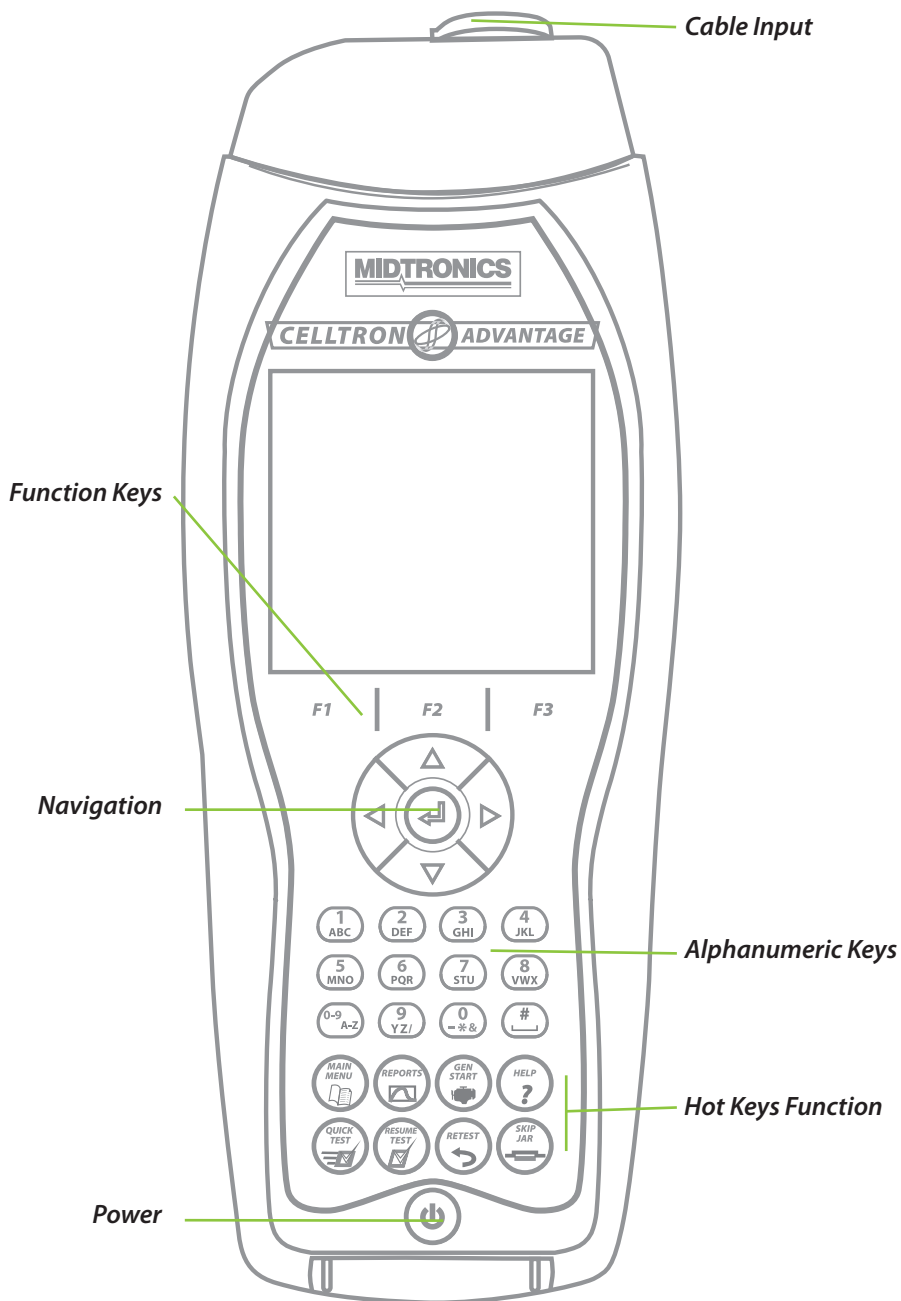

TOP

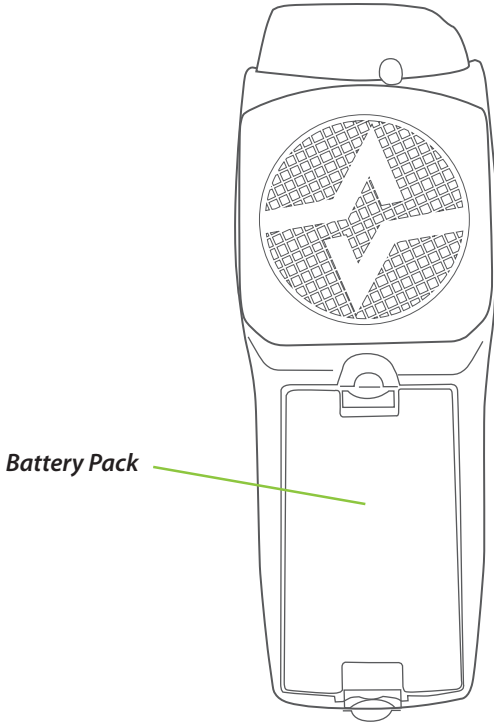
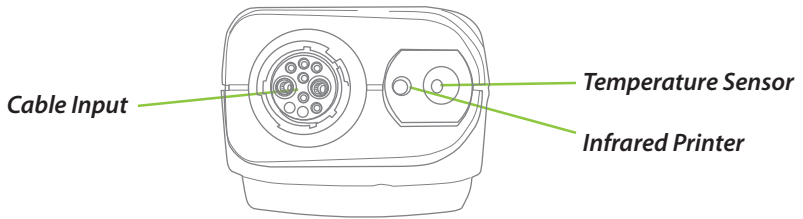

BOTTOM

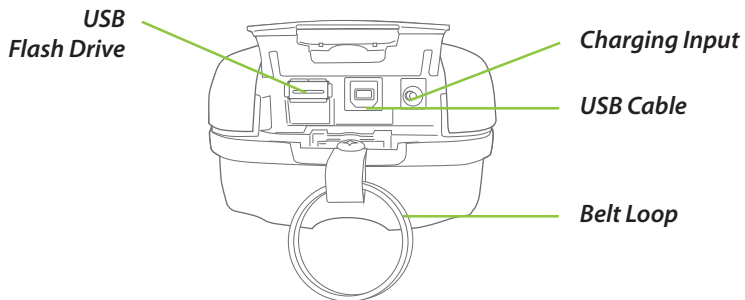

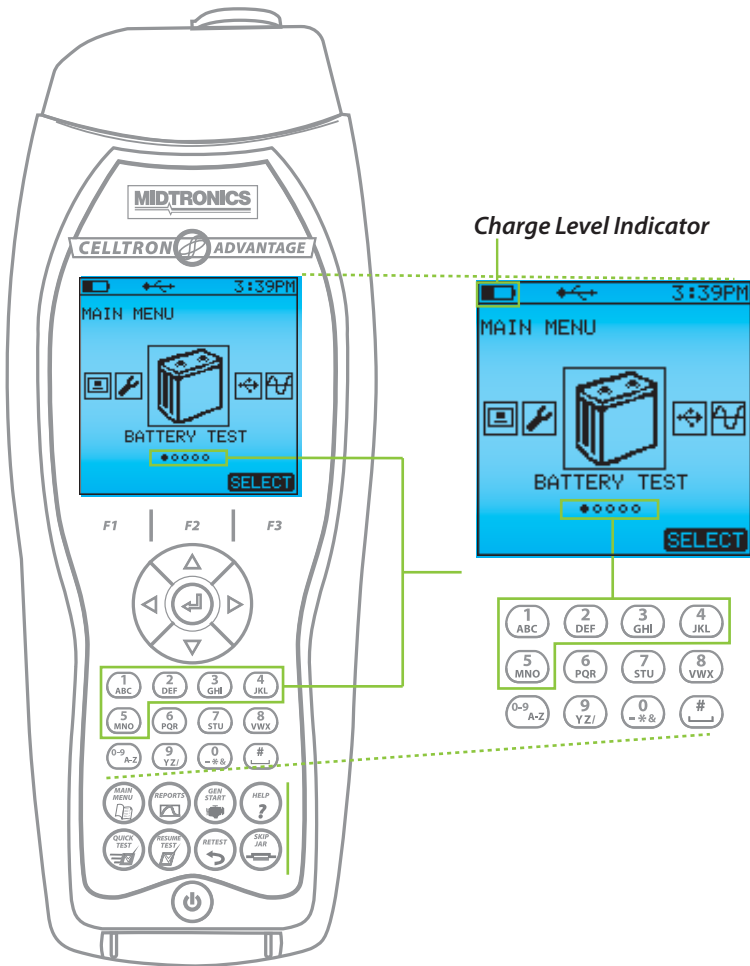

Quick Navigation

The numbers of dots on the menu screen (as highlighted) represent the sections of your **CELLTRON ADVANTAGE**. To quickly navigate thru these option, without having to continuously use the Navigation Button, you can use the number pad to get to the screen you want.

This quick navigation feature can be used anywhere in your **CELLTRON ADVANTAGE**.

1. Using the Quick Keys, you will be able to easily perform a function with the **CELLTRON ADVANTAGE**.
-



The Main Menu key allows a quick return to the main menu and all of its functions.



The Reports key generates the report options from both past and present battery tests.



The Gen Start activates the function (optional) to test a generator or engine start battery.



The Help key lists available support information



The Quick Test bypasses the base setup information for completing a battery test, thus starting test activity for a single battery/jar.



The Resume Test key resumes an interrupted test.



The Retest key enables you to retest a battery executed test on a single battery that has been previously tested. (Normally due to a suspect reading.)



The Skip Jar key enables you quickly skip a battery in a string during a test procedure. This is often employed when a battery is jumped out in a string or too low to test.

- Using the “**Main Menu**” Quick Key, you will be able to navigate thru the **CELLTRON ADVANTAGE** options. Select your desired screen and press the  button. This will open up your options per screen/section. Choose desired function.



Main Menu Quick Key

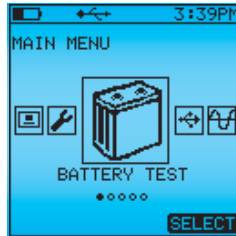

Begins the process of site, string, battery setup.

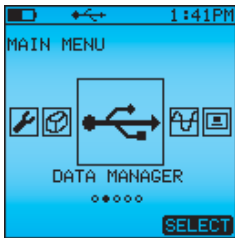

Transfer data to/from **CELLTRON ADVANTAGE**

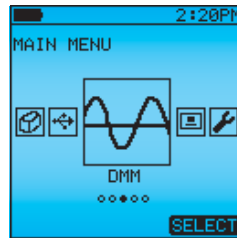

Digital Multimeter is available with an upgraded package.
DC / AC Voltage Measurement

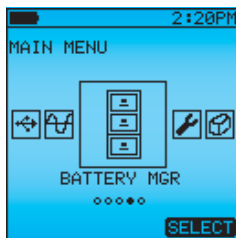

Internal battery reference base.

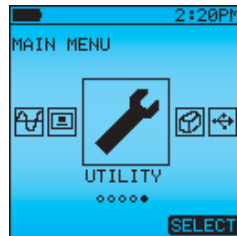

Utility setting for system including temperature, scale, clock, day/date, etc.

2. Utilizing the following screens you can choose the desired function you wish to perform.



Site Setup: For a standard battery test, you will setup a site. For a breakdown of this procedure, please reference page 14, Performing a Battery Test.

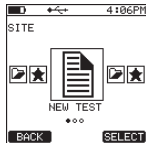

Let's you create new battery set up.

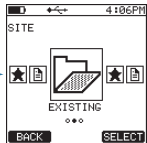

Let's you use existing sites.

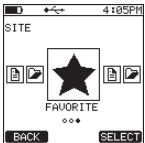

Pick your favorite site and plant from Utilities Menu

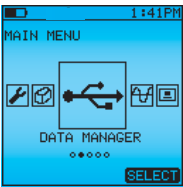

Data Manager: Allows the upload, download, and deletion data.

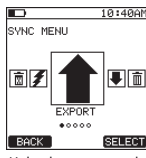

Upload your test results via USB flash drive to CELLTRAQ.

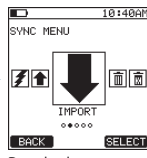

Download your test results via USB flash drive from CELLTRAQ.

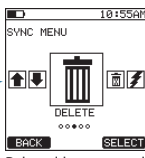

Delete old or unwanted results.

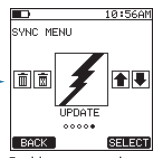

Enables you to update tester from file via USB.

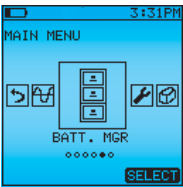

Battery Manager: Choose the manufacturer of the battery you are testing

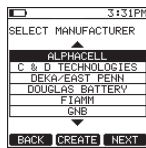

This screen allows you to choose the manufacturer of the battery you are testing.

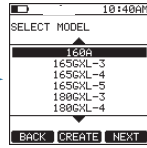

Choose model.

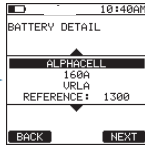

Configure detail.

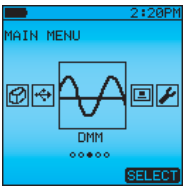

DMM Multi-meter: Allows the DMM multimeter Function.

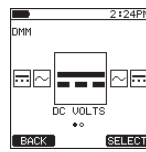

This screen allows you to choose DC Volts function

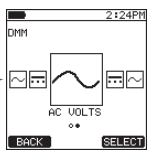

This screen allows you to choose AC Volts function

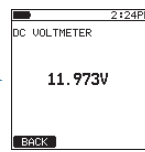

Typical DC Volts measurement.



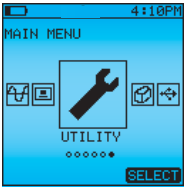

Utility: Helps you set the way you want your **CELLTRON ADVANTAGE** to function.

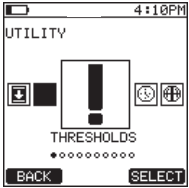

Set tester thresholds for voltage, conductance, and temperature.

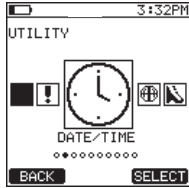

Set the date and time.

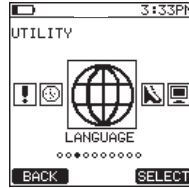

Choose preferred language.

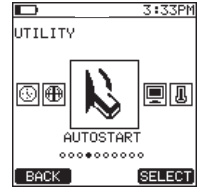

Sets tester to activate test process on contact.

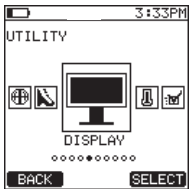

Set display brightness, contrast, etc.

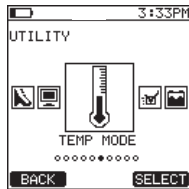

Set temperature mode: per jar or per string.

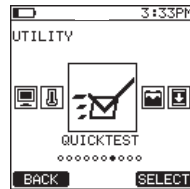

Enables you to start a test on a single cell or monoblock without first setting up a site.

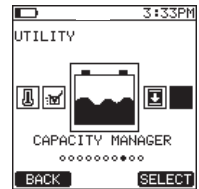

Enables you to record cell voltages on a timed interval during a capacity load test.

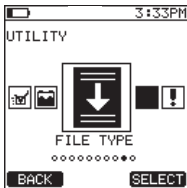

File type selection for exporting data use w/ **CELLTRAQ EXPRESS** or **CELLTRAQ ENTERPRISE**

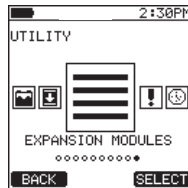

Select and activate additional capabilities of the **CELLTRON ADVANTAGE**.

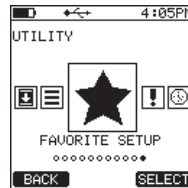

lets you access your favorite plant map.

1 Performing a battery test.

Getting Started: Before you start testing your battery you have to complete a few steps to properly retrieve and save your data. Below are the screens that will get you ready to start testing.



Site Setup: Enter a unique site or identifier.



Site Setup: Enter an identifier for the battery plant.

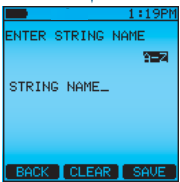

Site Setup: Enter a string name that can be unique or consistent with plant naming configuration.



Site Setup: Enter Tech I.D.

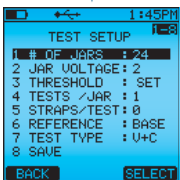

Follow prompts to input test parameters.

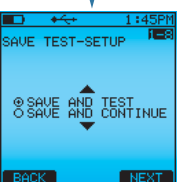

Choose save and test to begin test process or continue to additional setup.



Site Setup: To begin testing, a battery temperature must be taken. It is recommended that the measurement be taken close to the negative post of the first battery in the string.

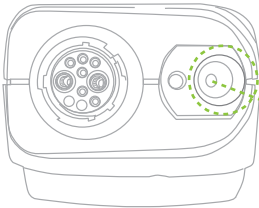
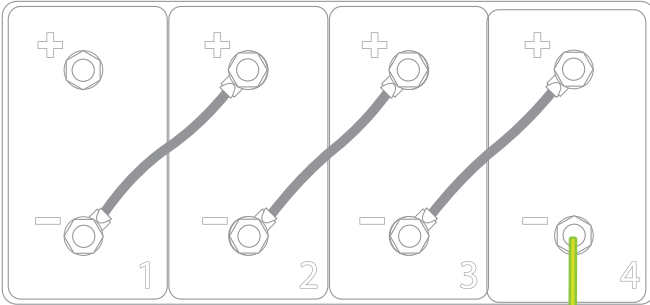

continued →



Site Setup: Next, attach clamps or probes to the battery posts.

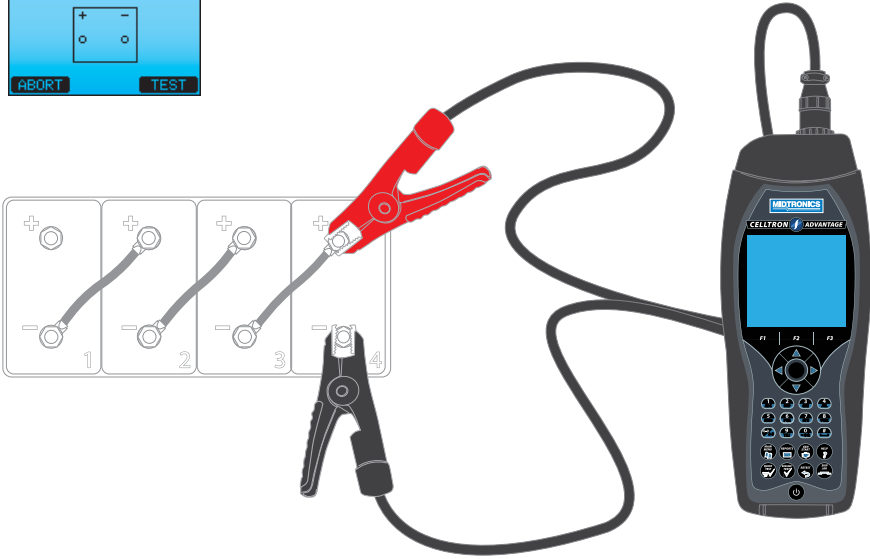

Progress screen is shown during the testing of your battery.



CELLTRON ADVANTAGE
will run a test on the number of jars in your battery and give you result per jars.

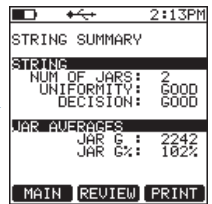

End Result Screen

Result Screen:

This screen shows the results after you have tested your battery.

Results: The Reports menu allows for the selection of individual battery string results and other system information. Graphs and results can be generated from this menu.

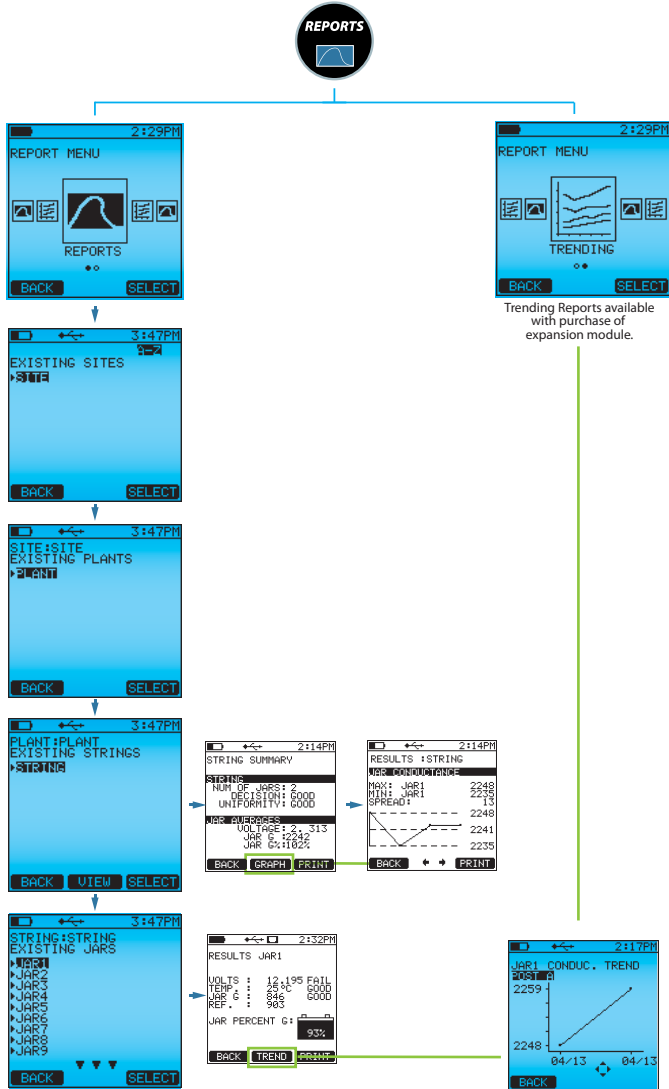

Use the UP/DOWN buttons to navigate from jar to jar.

Use RIGHT/LEFT buttons for post results.

Press  anytime to retest any jar in review screen.

CELLTRON ADVANTAGE

Add-Ons/Expansion Modules

Activate the full capabilities of your **CELLTRON ADVANTAGE**.
Contact Midtronics with your unit in hand for an activation key.

Corporate Headquarters
Willowbrook, IL USA
Phone: 1.630.323.2800

Canadian Inquiries
Toll Free: 1.866.592.8053

Midtronics China Office
China Operations
Shenzhen, China
Phone: +86 755 8202 2037

Midtronics b.v.
European Headquarters
Houten, The Netherlands
Serving Europe, Africa,
the Middle East,
and The Netherlands
Phone: +31 306 868 150

Latin America
Asia/Pacific (excluding China)
Contact Corporate Headquarters
Phone: +1.630.323.2800

Add-Ons & Expansion Modules: The following add ons for your **CELLTRON ADVANTAGE** are available for purchase

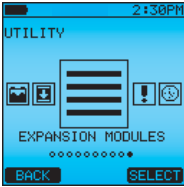

Expansion Modules Screen:
Access the available modules through this menu option.



Trending Screen:
This function provides ability to trend battery conductance from measurement to measurement.

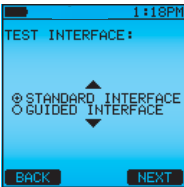

Guided Interface:
This function will provide the option for a technician-driven site and system setup based on general site and battery parameters. These parameters will be used in battery State Of Heath (SOH) determination.

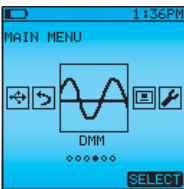

Digital Multimeter
Provides live voltmeter functions and AC volts function.

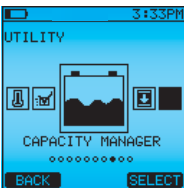

Capacity Manager:
Track, manage, and record traditional battery discharge information during load testing. Allows for discharge time record.

continued →



Gen Start Hot Key:

If activated, this activates the test function to determine state of health of generator starting batteries.

GEN START



Select option for Generator Start Battery or Fleet Automotive .Battery



Select battery rating units.



Enter battery rating.



Connect clamps/probes to battery.



Screen shows battery test in progress.

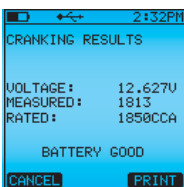

Battery tesy results screen. Press the F3 Key to print results.

The parts listed are all accessories that are available for the **CELLTRON ADVANTAGE** :



CA026
Interchangeable Test Cable



CA093 Probe Set
CA093R Red Probe
CA093B Black Probe



CA091
Battery Charger

Optional Accessories:



CA092 Clamp Set
CA092R Red Clamp
CA092B Black Clamp



CA034
Probe Extender Kit



CA096
Cradle Charger



CA090
Battery Pack



CA087
Printer



CA089
8 GB USB Flash Drive



CA049
USB Cable



CA069
Probe Replacement Kit



CA025
Long Probe Cable



CA024
Long Clamp Cable



CA031
Waffle Probe Tips

Not Pictured

Part No.

Accessory

CA028

CAD-5000 Kit Case

Troubleshooting

The troubleshooting tips in this section will help you resolve most testing and printing problems. For problems with the printer, digital temperature gun, or the PC software application, refer to their manuals or call Midtronics Customer Service for assistance. (See Patents, Limited Warranty, Service.)

Screen does not power on during testing (no text/graphics)

Check the connection to the jar.

The jar voltage might be too low (less than 1 volt) to test.

The analyzer's battery pack might need to be recharged or replaced.

Recharging the analyzer battery pack

Recharge the analyzer battery pack if:

The display does not turn on when you press the POWER button.

The screen displays:

****Warning****
Internal Battery Low!
Replace Batteries Soon!

Insert the AC adapter plug into the connector.

Connect the power of the AC adapter to an AC outlet.

- Periodically turn on the analyzer and check if the charge level indicator is black. When the battery pack is fully charged, disconnect the adapter from the analyzer and the AC outlet.



NOTE: The maximum charge time is 3 to 4 hours. Do not overcharge.

Replacing the analyzer battery pack

If the screen does not power on after recharging, replace the battery pack.

Press battery pack end tabs and pull battery pack.

Replace with charged battery pack.

If the problem persists, call Midtronics Customer Service. (See Patents, Limited Warranty, Service.)

Probe tip is bent or stops retracting

To replace a damaged a probe tip:

- Grasp the probe tip with pliers at the top of the sleeve.

CAUTION

Do not damage probe when removing from sleeve.

Grasping the sleeve that encases the probe tip can damage the tip.

- Pull the tip straight out.
- Grasp the replacement tip with the pliers and insert it into the sleeve.
- Push the probe tip into a soft surface, such as cardboard, until it hits the bottom of the sleeve.



NOTE: To obtain replacement tips, contact Midtronics Customer Service. (See Patents, Limited Warranty, Service)

Test Failure

If the analyzer fails to advance to the next jar count, try to retest.

Ensure clamps are connected and LEDs are off.

Test results do not print or print incorrectly

- ✓ Check that the printer is on
- ✓ Check that the tester IR transmitter are aligned
- ✓ Check printer batteries
- ✓ Fluorescent lights can affect IR transmission. Remove the tester from any fluorescent lights and re-transmit.

PRINTER STATUS LED

When a printer fault occurs, the STATUS LED flashes. You can identify the fault by the number of sequential flashes:

Solutions

- ✓ If the IR transmitter and receiver are not aligned, all the data may not print. The infrared ports on the top of the analyzer and on the printer (below the MODE button) should be pointed directly at each other. The maximum distance for reliable transmission between the ports is 18 inches (45 cm).
- To realign, press the BACK key to cancel the print. Verify alignment between the analyzer and printer; then try to print the test results again.
- ✓ If the message PRINTING appears on the screen, but no data are printing, press the BACK key to cancel the print. Turn off the printer and charge the printer battery for at least 15 minutes before attempting to print again. Align the analyzer and printer IR transmitters and print again.
 - ✓ Make sure the printer is on. The printer shuts off after two minutes of inactivity to conserve the battery. To turn the printer on, briefly press the MODE button. The green STATUS light should turn on. Make sure you are using the Midtronics printer provided with the **CELLTRON ADVANTAGE**. Other printers may not be compatible.
- ✓ Direct sunlight interferes with infrared data transmission/receiving. If the printer is not receiving data, remove the printer and the **CELLTRON ADVANTAGE** from direct sunlight. If the printed characters are not clear or are partially missing, recharge the battery and reprint.
 - ✓ Verify that a compatible communications protocol is selected in the printer setup. IrDA Mode is compatible with the Midtronics printer ("IrDA Physical Layer" on the printer's self-test printout). Refer to the printer manual for information.
 - ✓ If you are unable to print after ensuring the analyzer is functioning, the printer is on, the batteries are good, and the IR transmitter and receiver are aligned, see the printer manual for further instructions or call Midtronics. (See Patents, Limited Warranty, Service.)

PATENT

This product is made by Midtronics, Inc., and is protected by one or more U.S. and foreign patents.
For specific patent information, contact Midtronics, Inc. at +1 630 323-2800.

LIMITED WARRANTY

Midtronics products are warranted to be free of defects in materials and workmanship for a period of one (1) year from date of purchase. Midtronics will, at our option, repair or replace the unit with a re-manufactured unit. This limited warranty applies only to Midtronics products, and does not cover any other equipment, static damage, water damage, overvoltage damage, dropping the unit, or damage resulting from extraneous causes including owner misuse. Midtronics is not liable for any incidental or consequential damages for breach of this warranty. The warranty is void if owner attempts to disassemble the unit or to modify the cable assembly.

SERVICE

To obtain service, contact Midtronics at 1-800-776-1995 and press option 1. Have your model and serial numbers ready. This first step is critical as we will trouble-shoot the problem(s) over the phone, and many perceived problems are in fact resolved during this step. If the problem cannot be resolved, then the CS Agent will issue you a Return Material Authorization or RMA. This number becomes your tracking number. The final step is to return the unit to Midtronics freight prepaid (you pay), to the attention of the RMA number obtained.

In USA:

Midtronics, Inc.

Attn: RMA # xxxxx (this is the RMA number that you must obtain from Midtronics)
7000 Monroe St.
Willowbrook, IL 60527

In Canada:

Midtronics c/o FTN (FTN is Fed-ex Trade Networks –this is NOT a Midtronics facility)
Attn: RMA # xxxxx (this is the RMA number that you must obtain from Midtronics)
7075 Ordan Drive
Mississauga, ON L5T1K6

Midtronics will service the unit and reship the next scheduled business day following receipt (in most cases), using the same type carrier and service as received. If Midtronics determines that the failure was caused by misuse, alteration, accident, or abnormal condition of operation or handling, purchaser will be billed for the repaired product and it will be returned freight prepaid with shipping & handling charges added to the invoice.

Midtronics products beyond the warranty period are subject to the repair charges in place at that time.

Optional re-manufacturing service is available to return our products to like-new condition.
Out-of-warranty repairs carry a 3-month warranty. Re-manufactured units purchased from Midtronics are covered by a 6-month warranty.

MIDTRONICS



Stationary Power

midtronics.com

Corporate Headquarters

Willowbrook, IL USA
Phone: 1.630.323.2800

Canadian Inquiries

Toll Free: 1.866.592.8053

Midtronics China Office

China Operations
Shenzhen, China
Phone: +86 755 8202 2037

Midtronics b.v.

European Headquarters
Houten, The Netherlands
Serving Europe, Africa, the Middle East,
and The Netherlands
Phone: +31 306 868 150

Latin America

Asia/Pacific (excluding China)
Contact Corporate Headquarters
Phone: +1.630.323.2800